

Kippenhok Loekie

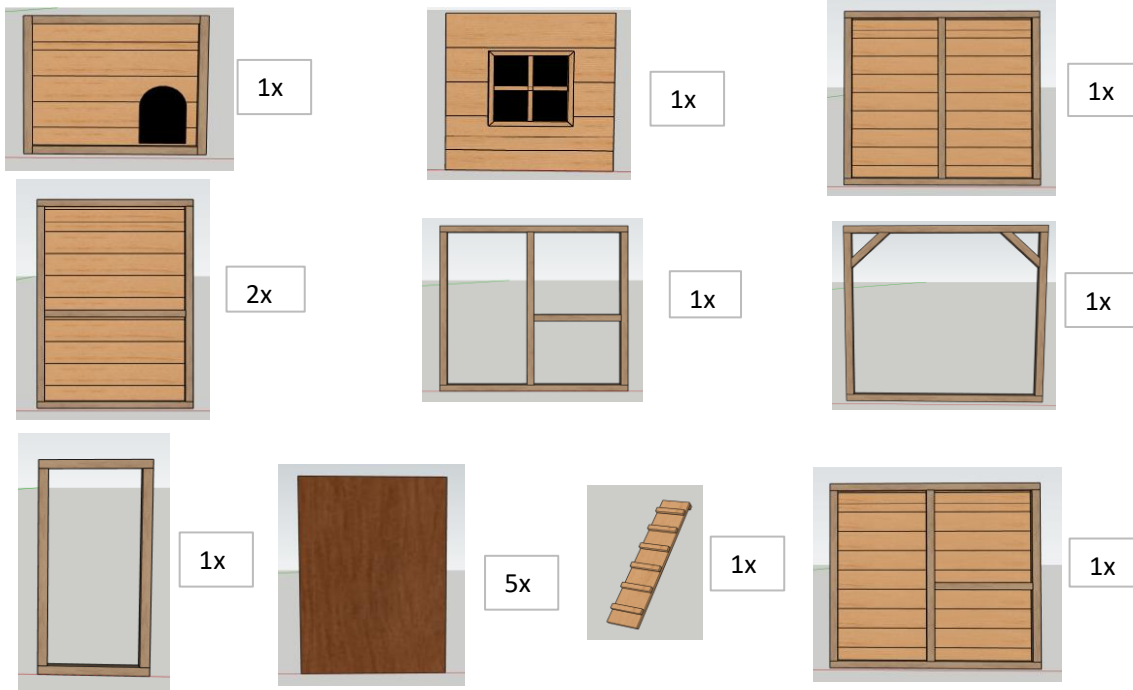

Benodigheden:

- Schroefmachine
- Rolmaat
- Bit pz2
- Bit pz1
- Boortje 4mm (is meegeleverd)
- *ALLE SCHROEVEN VOORBOREN***



Dakbedekking
-3x 232x45cm



Rabat

- 3x 79cm - 30° - 30°
- 3x 48cm - 30° - 30°

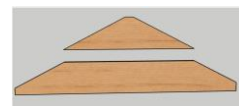

Lat

- 2x 71,4cm (30x16mm)
- 2x 34cm (65x16mm)
- 4x daktrim 60cm



Balk 44x44mm

- 2x 79cm
- 1x 57cm
- 10x 51,6cm - 30° - 60°

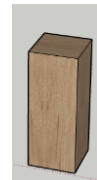

Overige

- 1x Legbak
- 4x Geheng 20cm
- 2x schuifslot

- 32x Schroef 70mm
- 30x Schroef 40mm
- 94x Schroef 30mm
- 16 Schroef 20mm

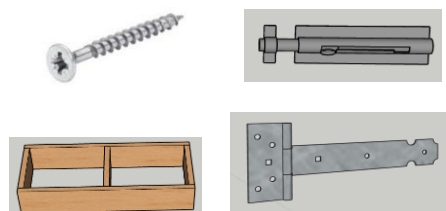

1.

2x Lat 30x16mm - 2x 71,4cm
6x Schroef 30mm

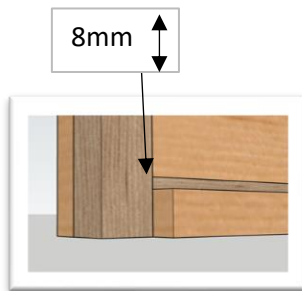

2.

3x Schroef 70mm



Onder/bovenaanzicht

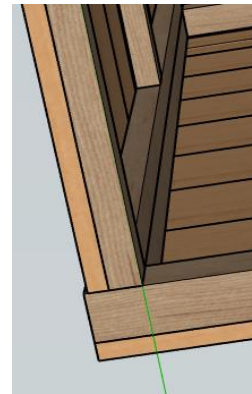

3.

3x Schroef 70mm



4.

3x Schroef 70mm

Onder/bovenaanzicht



5.

3x Schroef 70mm

Onder/bovenaanzicht

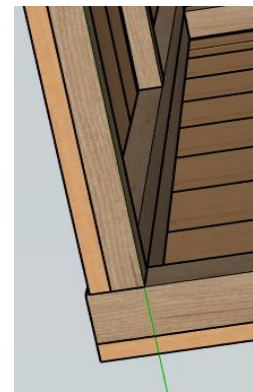
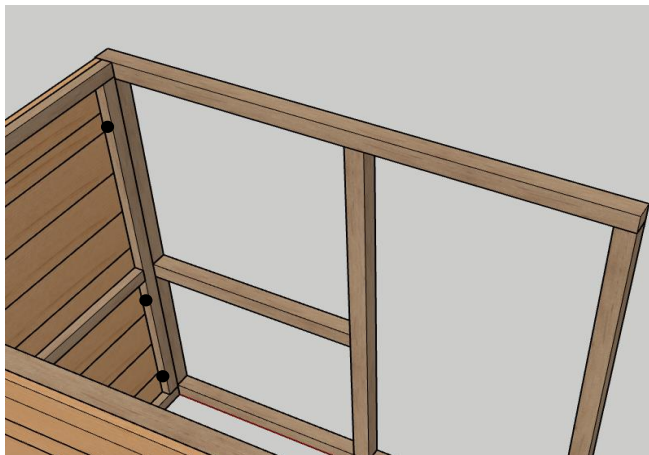

6.

4x Schroef 70mm

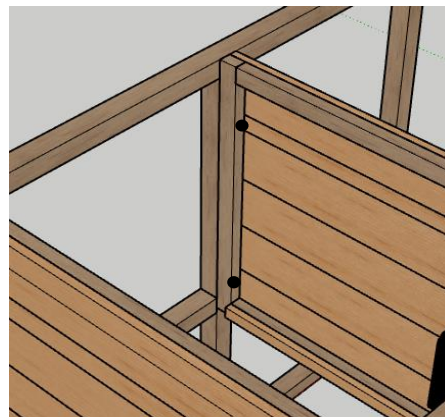
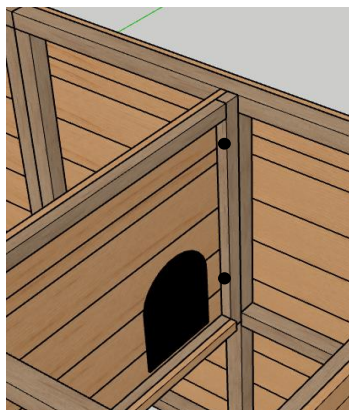

7.

6x Schroef 70mm

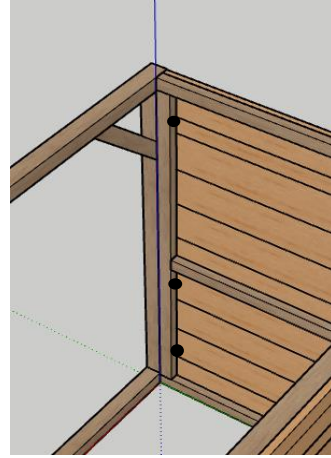

8.

1x betonplex bruin 55x85cm

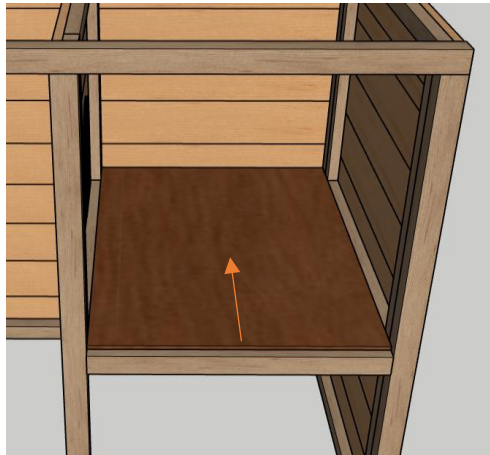

9.

4x geheng 20cm
12x Schroef 30mm

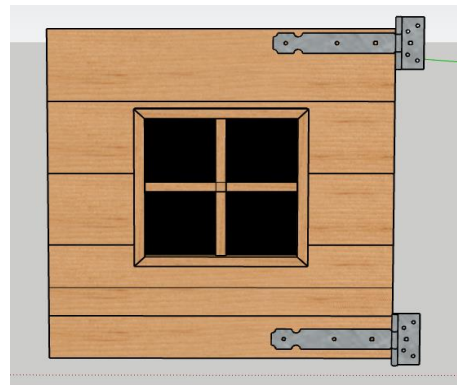
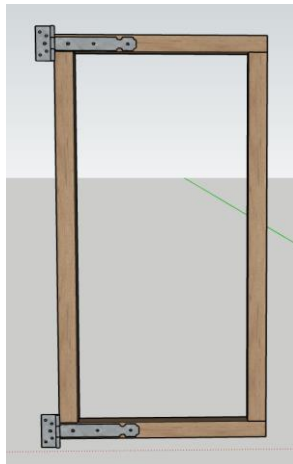

10.

2x Schuifslot
8x Schroef 40mm
16x Schroef 20mm



11.

2x Lat 65x16mm - 34cm
1x Balk 44x44mm - 57cm
1x Legbak
12x Schroef 30mm

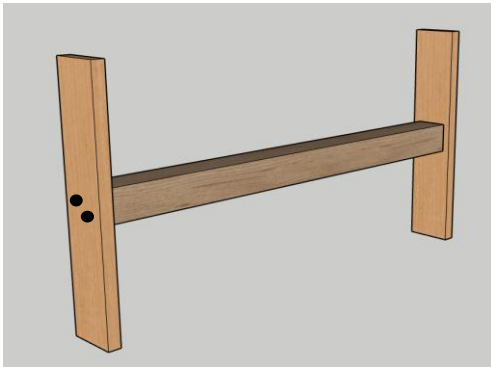

1.



2.

12.

2x Balk 44x44mm - 79cm
8x Schroef 70mm

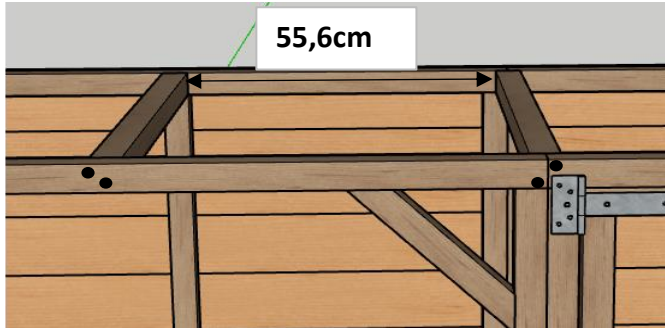

13.

10x Balk 44x44mm - 51,6cm 30* - 60*
30x Schroef 40mm

1.

19mm ←→

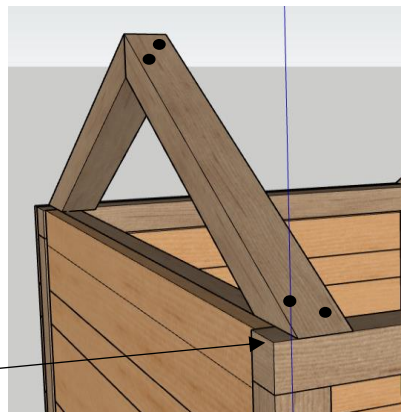

2.

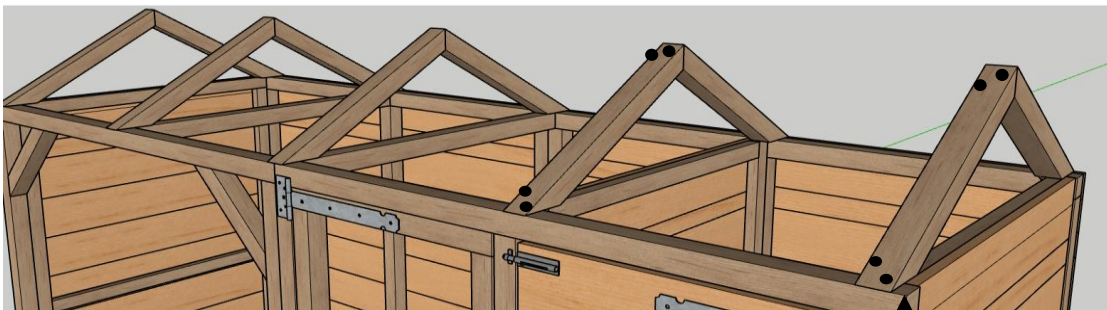

19mm ←→

14.

3x Rabat 79cm - 30* -30*
3x Rabat 48cm - 30* -30*
24x Schroef 30mm

1.

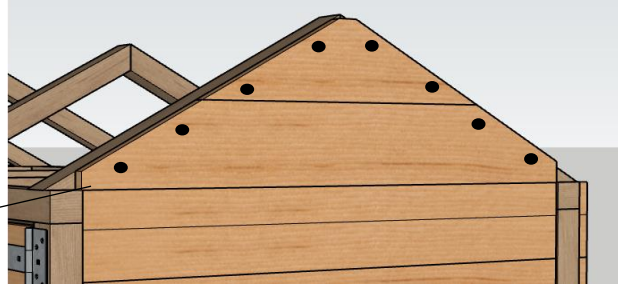
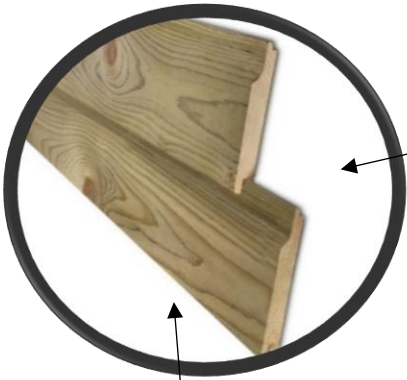

2.

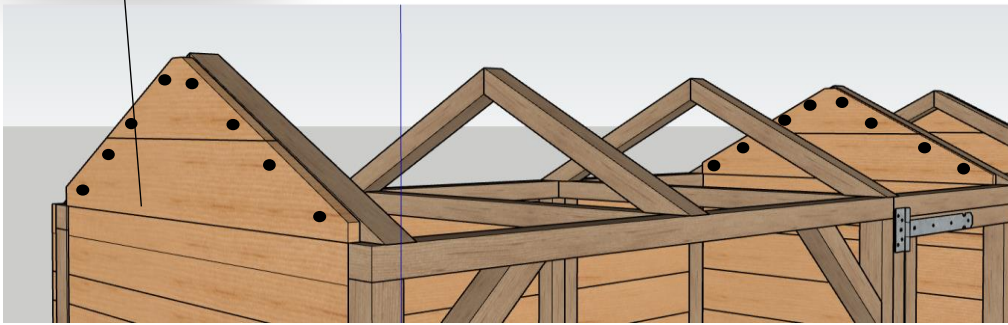

15.

4x Spaanplaat groen 116x55cm
24x Schroef 30mm

22mm ↔

22mm ↔

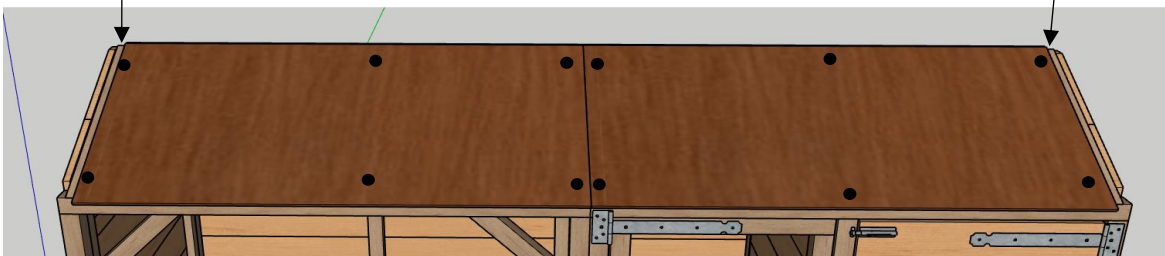

16.

3x dakbedekking 232x45cm



Verwijder de folie van de onderzijde en verdeel hierna de dakbedekking over de betonplex platen.

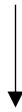

11cm

1.

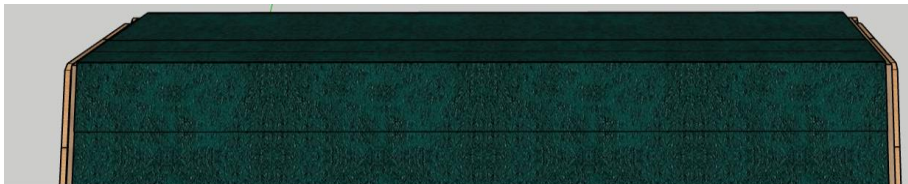

2.

17.

4x Daktrim 60cm
16x Schroef 30mm

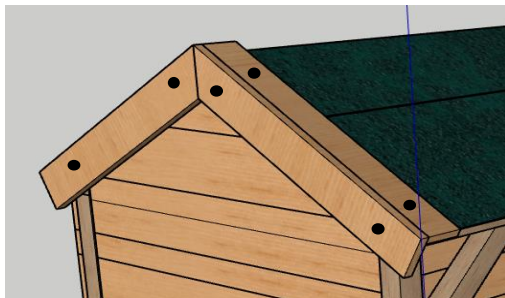

Legnest

1.

Verwijder twee planken aan de kopzijde

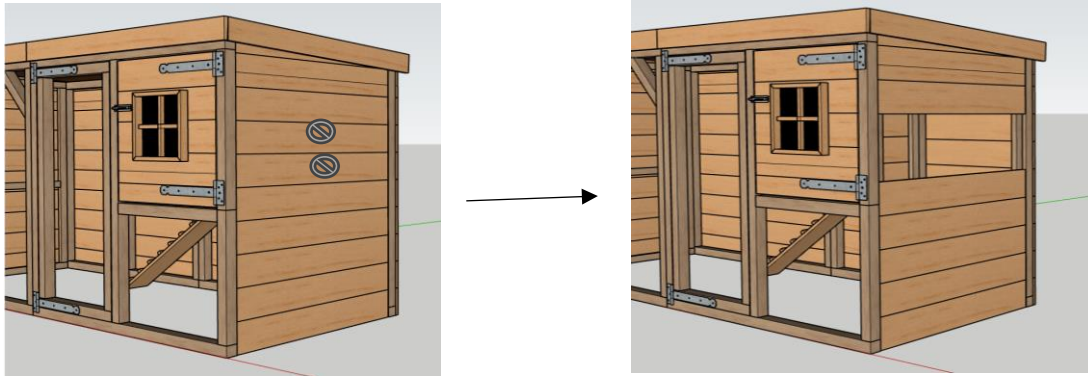

2.

4x schroef 60mm

